



The Best in Hobby Electronics

www.brickstuff.com • Visit <http://forum.brickstuff.com> for usage ideas, tips, and more

## Welcome, and Thank You!

Thank you for purchasing this Brickstuff product. We hope you enjoy using it as much as we enjoyed creating it. The parts in this box are only part of our story, only part of what we're working hard to develop. Our goal is to create the most flexible and exciting line of hobby electronics products for you to use in all of your fantastic creations. All of these products will work together, and you won't need to be an electronics expert to use them. So keep building amazing things—we'll help you bring them to life.

Thanks again for supporting us. We couldn't do this without you!

--- The Brickstuff Team  
[support@brickstuff.com](mailto:support@brickstuff.com)

# Basic 10" Video Player with Volume Memory

## INSTRUCTIONS FOR USE

This kit includes the following parts:

- One 10" video player module with speaker, volume buttons, USB input connector, Brickstuff power cable, and demo video pre-loaded.
- One USB data/power cable with USB-micro plug
- One BRANCH04 Brickstuff adapter (used to power the video player with a Brickstuff power source)

Here are some things to keep in mind when setting up and using your video player module:

- The video player requires a 5-volt power source, such as a USB battery bank, that is capable of generating enough power to charge a tablet or smartphone. If using a Brickstuff power source connection, make sure the source is a 5-volt source such as our USB power cable or Power Functions power source. Do not use any of our battery packs to power this video screen. These are not able to generate the amount of power required.
- Although you need to connect the video player to a computer using the included USB data/power cable in order to copy video files onto the module, the module will not play videos when connected to a computer with the included USB cable. To get videos to play, you will need to connect the USB cable to a USB battery bank or iPhone/iPad-type charger. Whenever the video player is connected to a computer, it is in "data transfer" mode and will not play videos.
- Videos loaded onto the player will play in order. It is not possible to change videos or pick a specific video to play; the player will play all loaded videos in a continuous loop once power is turned on.
- This video player includes two buttons: one for volume up and one for volume down. Volume settings are preserved even when power to the player is turned off.
- The video player has enough onboard memory (100MB) to store up to 30 minutes of compressed video. If your video is too large to fit onto the module, you can follow the directions later in this document and use free online tools to reduce the size of your video file.

## ADDING VIDEO FILES TO THE PLAYER

To add or change video files on the player, follow these steps: (also see Figure 1 on the next page)

1. If you are powering the video player using the Brickstuff power cable, disconnect that cable from its power source.
2. Using the included USB cable, connect one end to the USB connector cable on the video player, and connect the other end to your computer. You should see the video player appear as a connected memory disk, like a USB memory stick would appear when connected.
3. Open the folder representing the video player, and copy/delete files as needed.
4. Disconnect the USB cable from your computer and connect/re-connect to your external power source. As explained above, the player will not play videos when connected to a computer.

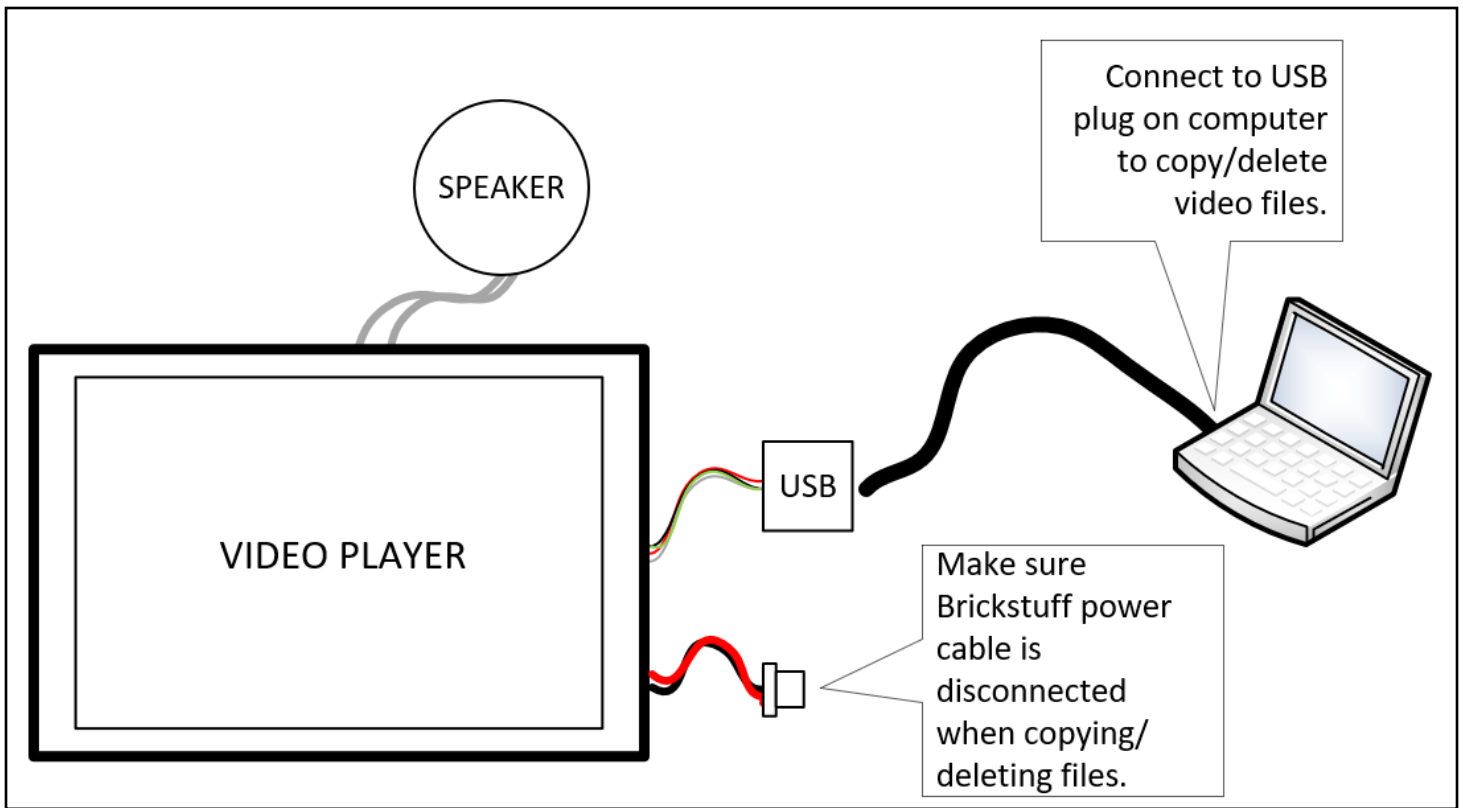
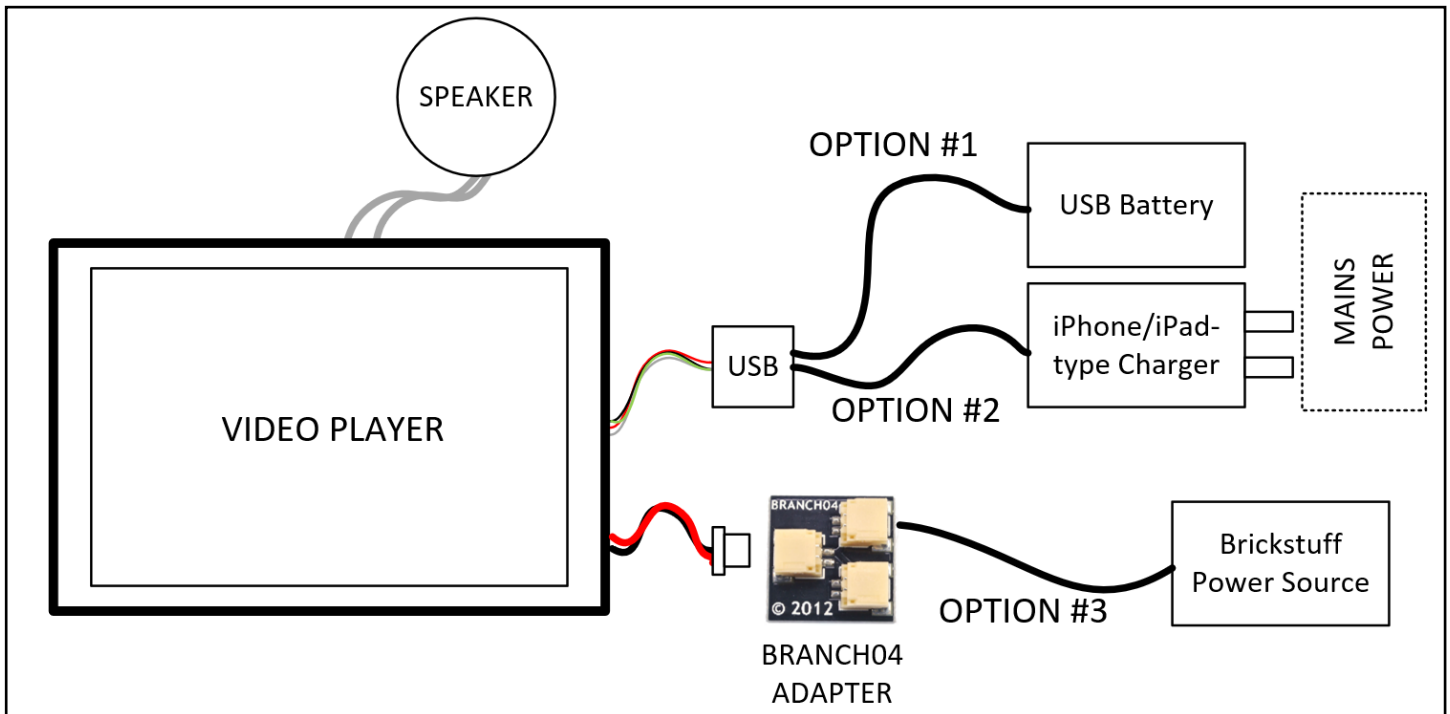

**FIGURE 1: Connecting the Video Player to a Computer to Copy/Delete Video Files.**

## VIDEO PLAYER OPERATION

To operate the video player, connect it to a power source as shown in Figure 2 below. Once connected, the video player will begin playing its stored videos in order, in a continuous loop. As shown in Figure 2, there are three main options for powering the video module:

1. Connection to a USB battery bank using the USB cable included with this kit.
2. Connection to an iPhone or iPad-type charger (connected to mains power) using the USB cable included with this kit.
3. Connection to a Brickstuff power source using the BRANCH04 adapter board included with this kit.



**FIGURE 2: Three Options for Powering the Video Player Module.**

# FORMATTING VIDEOS FOR THE PLAYER

If your video files are too large to fit into the video player's memory, or if the volume of your video file is too loud when played, you can adjust these aspects of the files using a free online file conversion tool called Cloud-Convert. To access this tool, open a web browser on your computer and navigate to <https://cloudconvert.com>. Next, click the red "Select File" button on the main page to select the video file on your computer and upload it. (see the blue arrow in the screenshot at right)

Once you have selected your video, you will have the option to select the type of video file to convert to. As shown by the green circle in the second screenshot, click "MP4" (even if your file is already in MP4 format).

Once you select MP4 as the file format, you will see a wrench icon appear (see the green arrow). Click the wrench icon to open the configuration window. **DO NOT click on the "Convert" button.** The parameters you can adjust are shown below.

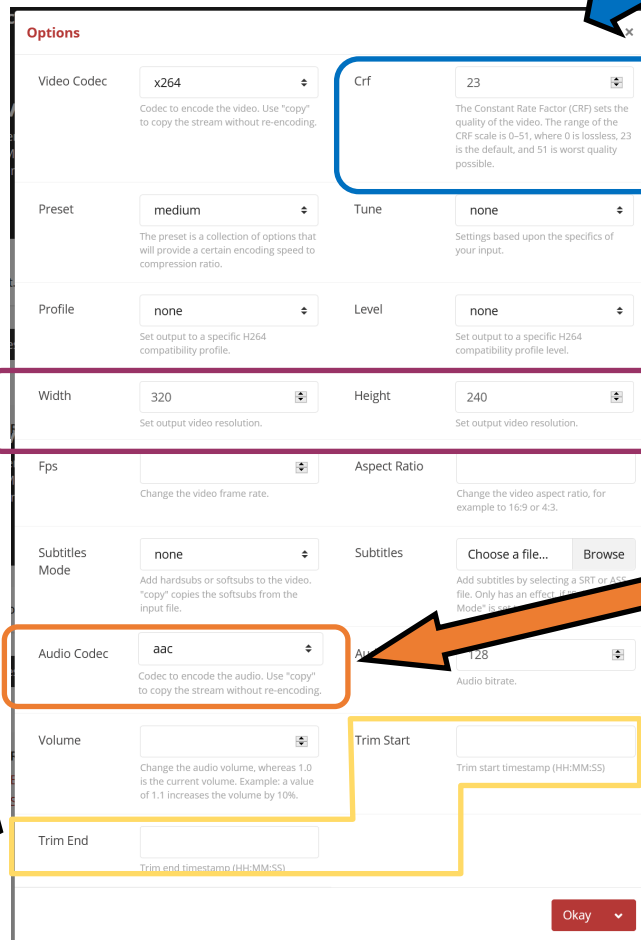
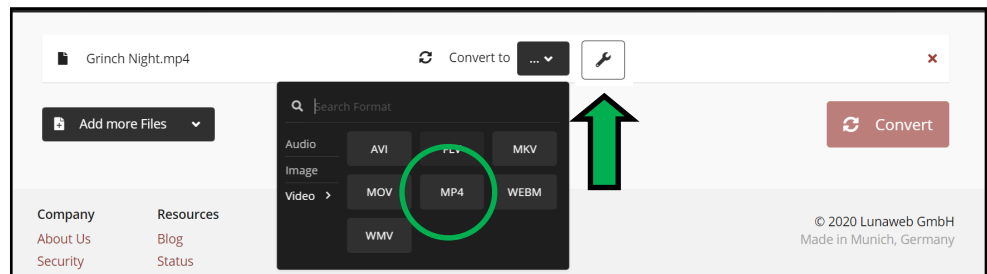
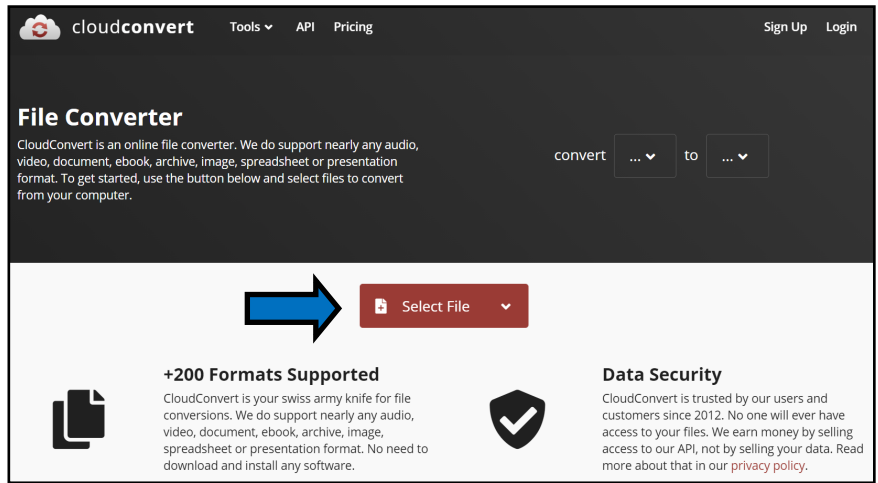

"CRF" can be adjusted to reduce the file size of your video. Set between 23 (default) and 51 (lowest quality) to reduce the file size. You may need to try several times to get your file reduced to a size small enough to fit onto the video player module. Remember, the total memory on the module is 100MB.

Set the Width to 320 and the Height to 240.

You can also set the "Trim Start" and "Trim End" fields to clip your video file and reduce size.

Keep the Audio Codec set to "aac".

Once you have set your parameters, click "Okay" to return to the main screen.

# BEGINNING CONVERSION

Once you have entered your conversion settings and clicked the "Okay" button, you will return to the main web page, where you can choose to either add more files by clicking on the black "Add more Files" button, or you can begin converting your video with your selected parameters by clicking the red "Convert" button (see the green arrow above).

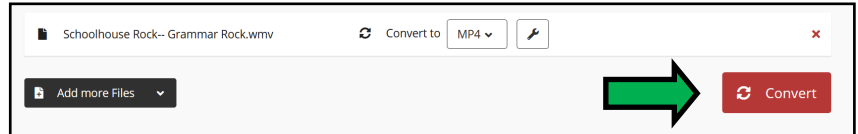

When you click "Convert," your entire video will be uploaded to the cloudconvert.com website. Depending on your Internet connection speed and the size of your video file, this can take a long time. Do not close your web browser or turn off your computer during the upload. If you are uploading a very large file, it may take several hours to upload— make sure you allow enough time for the upload to complete.

Once your video file has finished uploading, you will see "PROCESSING" as shown in the screenshot at right, and there will be a progress bar on the screen showing how much of your video has been processed.



When your file has finished converting, a window will open up in your browser and the video will begin playing. You can then close the playback window, and you should see the main screen again, this time with a green "Download" button as shown by the blue arrow above. Click the "Download" button to download your converted video and save to your computer.

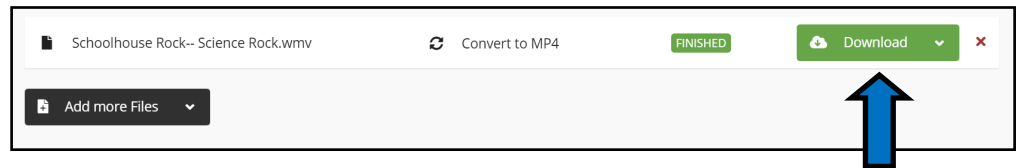

**Do not close your browser window until you have checked the size of your downloaded video and read the paragraph below!**

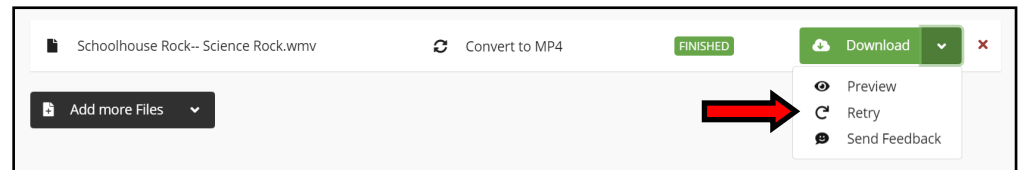

If your video still is not small enough to fit onto the player module, you don't need to upload the whole video again to try different settings. Instead, from the main screen, click the arrow on the right side of the "Download" button, and you will see a drop-down menu. By clicking "Retry" (see the red arrow above), a duplicate copy of your already-uploaded file will be created, and you will be able to change the settings for this copy and try conversion again without needing to re-upload. Keep trying adjustments to the "CRF" setting (using higher numbers up to 51) until your file is under 100MB in size.

# CONVERSION ERRORS

If the cloudconvert.com application is not able to read or process your video file, the file may be damaged. Unfortunately we are not able to provide support for damaged or unreadable video files, or for any other specific issues related to video compression or conversion.

There are a number of online tools that can help repair damaged video files. To find these tools, search the Internet using the phrase "repair damaged video file" and the file extension of your original video. For example, if your video is a QuickTime video, which would have the file extension .MOV, search for "repair damaged video file mov".

Once you have repaired your file, you can try uploading to cloudconvert.com again.

Basic 10" Video Screen (VS100) v1.0, APRIL 2021.

Brickstuff, QuickKit, BrickPixels, and the Lighting Gear Logo are trademarks of Enthusiast Enterprises, LLC. This product is subject to the warranty and liability policy set forth in the Warranty section of our website, [www.brickstuff.com](http://www.brickstuff.com).

Contact us at [support@brickstuff.com](mailto:support@brickstuff.com) with any questions or issues, or post in our Online User Forum: <https://forum.brickstuff.com>